

Martini deECO Collection



 martini

GORGIAS
GROUP

Contents

About CSR Martini	03
Why Acoustics Matter	04
Environment	05
dECO finishes	06
dECO Felts	08
dECO Velour	10
dECO Product Selection Guide	14
Performance	15
dECO Quiet Panel	16
dECO Flex	18
dECO Blades	22
dECO Screens	26
dECO Clouds	28
dECO Ceiling Tiles	30
dECO 3D Tiles	34
dECO Stick It Tiles	36
dECO Deluxe	40
dECO Quiet Board	41
dECO Edge	44
VERTO™	46

Cover page features dECO Blades with Verto™ showcasing Wedge 300mm blades in dECO Felt Ariel

About CSR Martini

At CSR Martini, we know the difference between sound and noise.

Proudly Australian manufactured with over 27 years of experience behind us, our acoustic products have been specifically engineered to perform across multiple environments - and even within different interior spaces.

Offering non-exposed insulation, semi-exposed absorptive products and decorative acoustic solutions to be used alone or in combination, we are the experts at integrating design and performance so that your desired outcome is reached both functionally and aesthetically.

From prominent Australian landmarks to industrial overhauls, whether it be for a commercial, hospitality or cultural space, recording studio, schools, theatres or convention centres, we sustainably engineer solutions for the most challenging acoustic layouts to ensure auditory excellence.





Why acoustics matter

We believe that sound can impact our environment for better or worse.

Studies show that poor acoustics can reduce student learning, productivity in workplaces, affect hospital recovery periods, as well as detract from our experience in social settings. The effects are wide and far reaching.

Couple this with increased trends towards more collaborative, open-plan spaces, actively managing noise levels is paramount to ensure you get the most out of your surroundings.

At CSR Martini, we engineer environments that transform the collective experience of those within them, reducing the impact of noise where it's not wanted.

Experience the difference with our range.

Features dECO 3D Tiles Shatter in dECO Felt Neptune, Lace and Granite.

Environment

At CSR Martini, we believe we all have a role to play in looking after the environment. No doubt you feel the same.

To us, it's not just about creating exceptional quality products. We ensure our manufacturing impact, our footprint and every single touch point from production to final delivery is considered.

Why? Because as a responsible corporate citizen, we are committed to leaving our next generation and the world better than we found it.

But actions speak louder than words. We are proud to say we are leading the way by ensuring our products, along with our manufacturing process, have been certified to independent environmental and product health assessments.

- Products with recycled content reduce greenhouse gas emissions
- High reusable potential
- Products manufactured from thermally bonded polyester fibre have a minimum of 60% recycled fibre content from PET packaging such as empty drink bottles
- The products are 100% recyclable
- No ozone-depleting gases are used during the manufacturing process
- No red list chemicals are present
- Safe, non-irritant, non-toxic, and non-allergenic

CSR Martini products are proudly:

- GreenTag^{Cert}™ certified
- Environmental Product Declaration (EPD) certified in accordance with ISO 14025
- Product Health Declaration (PHD) certified
- Declare certified
- Suitable for Green Star™ projects



dECO Finishes

CSR Martini's dECO fabric range is available in either a Flat Felt or Velour finish.

The dECO colour range offers freshness and vitality to any interior space. Colours have been inspired by the beauty of our world. From the calming palette of neutrals to the vibrant pops of life, dECO Felt and dECO Velour will elevate your design whilst delivering acoustic performance.

The impact colours have on individuals is extraordinary. It can sway thinking, change actions, and cause reactions. It can irritate or soothe your eyes, raise your blood pressure or suppress your appetite.

At CSR Martini we know when colours are used in the right way they can add so much more to the space. Have design freedom with our extensive range of fabric colours and finishes.



Features dECO Blades Wedge 200mm in dECO Felt Apple.



Felt Flat Acoustic Fabric

Application	Bonded to fabricated Martini products: dECO Blades, dECO Clouds, dECO Screens, dECO 3D Tiles, dECO Stick It and dECO Ceiling Tiles
Thickness	1-2mm
Width	1350mm
Fire resistance	Complies with AS 5637.1 and is tested to AS/ ISO 9705 and achieves Group 1-S SMOGRA less than 100 m ² /s ² x 1000
Acoustic performance	Tested to AS/ISO 354 and achieves NRC 0.04 direct fix

Sustainability



Snow

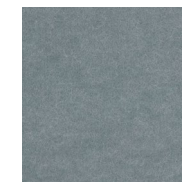

Neptune



Moss

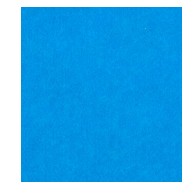

Bolt



Lace

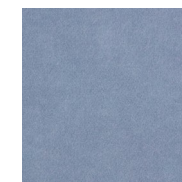

Nordic Sky

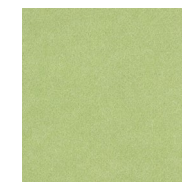

Apple



Bumble Bee



Porcelain



Summit



Citrus

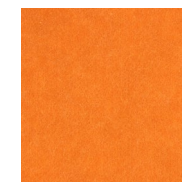

Tiger



Ice

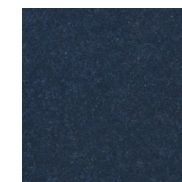

Sapphire



Shamrock

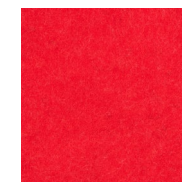

Cherry



Granite



Ash

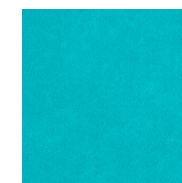

Ariel



Candy

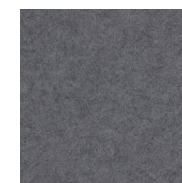

Platinum

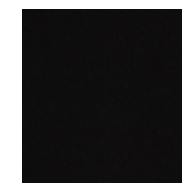

Pitch

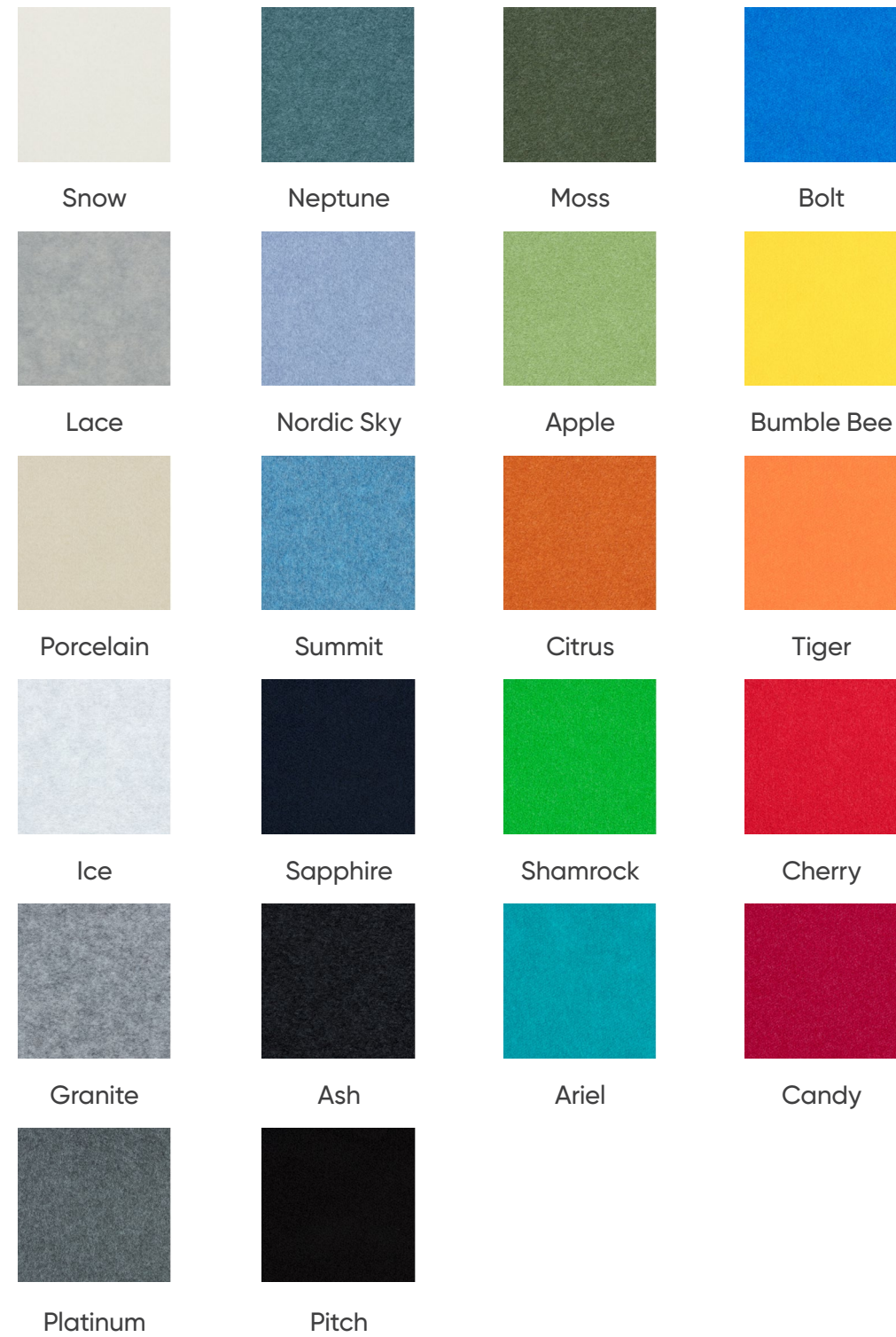

Velcro® Receptive Acoustic Fabric

Application	Velcro® receptive fabric bonded to fabricated Martini products: dECO Quiet Panel and dECO Flex
Thickness	3-4mm
Width	1350mm
Fire resistance	Complies with AS 5637.1 and is tested to AS/ ISO 9705 and achieves Group 1-S SMOGRA less than 100 m ² /s ² x 1000
Acoustic performance	Tested to AS/ISO 354 and achieves NRC 0.04 direct fix

Sustainability





Medical Centre

Wall features dECO Quiet Panel with dECO Velour Platinum. dECO Edge in clear anodised used to highlight panelling detail. Ceiling features Martini Soffit XXHD 50 in black with dECO Clouds suspended below in dECO Felt Granite.

dECO Collections

Design-Led Acoustics

dECO is a high performance decorative acoustic range proudly manufactured in Australia.

Selecting the right dECO product is essential to ensure the balance of acoustic performance and design to create the right environment.

dECO Product Selection Guide

	Application		Available Finishes			Installation Options				
	Wall	Ceiling	dECO Felt	dECO Velour	Board	Direct Fix	Soffit Suspension	Ceiling Grid Suspension	Plasterboard Suspension	Exposed Ceiling Grid System
dECO Quiet Panel	•	•		•		•				
dECO Flex	•			•		•				
dECO Clouds		•	•				•	•	•	
dECO Blades	•	•	•			•	•	•		
dECO Screens	•	•	•			•	•	•		
dECO Ceiling Tiles		•	•							•
dECO 3D Tiles	•		•			•				
dECO Stick It	•		•			•				
dECO Deluxe	•	•			•	•				
dECO Quiet Board	•	•			•	•				

Performance

Acoustics is a silent science of sound frequencies and movement.

As silent performers, our products are engineered to excel by fibre characteristics, density and varying thickness of our range. We measure internal performance of sound through a measure called the Noise Reduction Coefficient (NRC). The NRC is a simplified number that's the arithmetic average of four frequencies - 250, 500, 1000 and 2000 Hz. The higher the NRC, the greater the sound absorption at those frequencies.

Investment in extensive acoustic testing offers you the assurance that comes with actual results rather than just opinions. Our products deliver exceptional performance and we have the results to prove it. Our products excel in some of the most challenging acoustic applications including recording studios, concert halls, auditoriums and theatres.

CSR Martini stands both the test of time, as well as the test of sound.



martini

dECO QUIET PANEL

High Performing Fabric Faced Acoustic Panel

Intended use Interior wall, ceiling panelling and pin boards

Thickness 8 mm, 15mm, 25mm, 50mm
Tolerance: +/- 2mm

Panel size 2420mm x 1210mm 2720mm x 1210mm
Tolerance: length +/- 10mm width +/- 5mm

Fire resistance Complies with AS 5637.1 and is tested to AS/ ISO 9705 and achieves Group 1-S SMOGRA less than 100 m²/s² x 1000

Acoustic performance **Tested to AS/ISO 354 and achieves:**
8mm NRC 0.30 direct fix
15mm NRC 0.50 direct fix
25mm NRC 0.85 direct fix
50mm NRC 1.00 direct fix

Warranty 15 year product warranty

Sustainability



Declare.



Framing System

dECO Edge to suit 12mm, 25mm and 50mm dECO Quiet Panel available in Clear Anodised Silver, Matt Black and Flat White finish. Refer to dECO Edge on page 44 for more details.

Finish



As shown on page 10



Wall features dECO Quiet Panel in dECO Velour Lace and Porcelain.
Ceiling features Troldekt Ultrafine 25mm in black.





Velcro® Receptive, Flexible Acoustic Wall Covering

Application	Interior wall, ceiling panelling and pin boards
Thickness	10-12mm
Width	1220mm Tolerance: +/- 5mm
Length	25m Other lengths available upon request. Minimum length 7m. There may be a 10% over or under supply.
Fire resistance	Complies with AS 5637.1 and is tested to AS/ ISO 9705 and achieves Group 1-S SMOGRA less than 100 m ² /s ² x 1000
Acoustic performance	Tested to AS/ISO 354 and achieves: NRC 0.40 direct fix
Warranty	15 year product warranty

Sustainability



Finish



Features dECO Flex in dECO Velour Bolt and Cherry



Wall to ceiling features dECO Blades Wedge 100mm in dECO Felt Neptune.
Reception wall features dECO 3D Tiles Geo and Incline in dECO Felt Ash, Platinum and Lace.

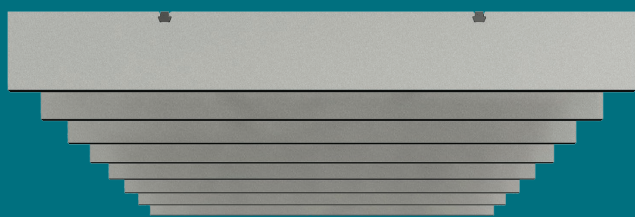

Linear

Blade Length	2400mm, 1800mm and 1200mm
Blade Thickness	27mm
Blade Height	Available in 100mm, 200mm and 300mm

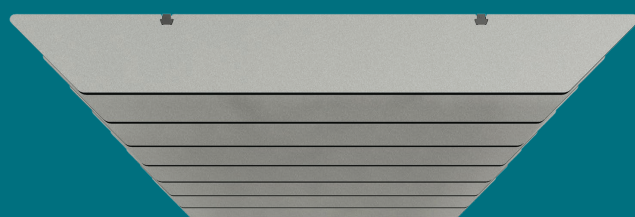

Wedge

Blade Length	2400mm, 1800mm and 1200mm
Blade Thickness	27mm
Blade Height	Available in 100mm, 200mm and 300mm

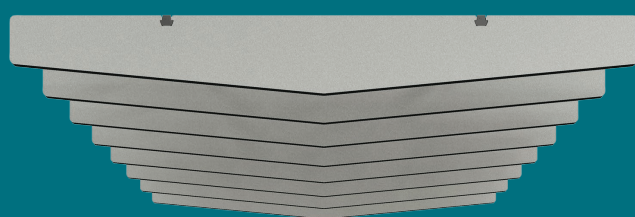

Arrow

Blade Length	2400mm, 1800mm and 1200mm
Blade Thickness	27mm
Blade Height	Available in 200mm and 300mm

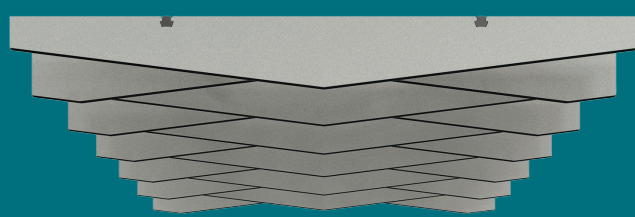

Movement

Blade Length	2400mm, 1800mm and 1200mm
Blade Thickness	27mm
Blade Height	From 245mm to 270mm

Acoustic Blades with Verto™ Hanging System

Intended use	Interior decorative acoustic blades for ceilings and walls
Designs	dECO Blades Linear, dECO Blades Wedge, dECO Blades Arrow, dECO Blades Movement
Blade thickness	27mm Tolerance: +/- 2mm
Blade widths	Available in 2400mm, 1800mm and 1200mm
Fire resistance	Complies with AS 5637.1 and is tested to AS/ ISO 9705 and achieves Group 1-S SMOGRA less than 100 m ² /s ² x 1000
Acoustic performance	Tested to AS/ISO 354 and achieves NRC 0.90 Based on dECO Blade Linear 2400mm x 200mm x 27mm in 6m ² module with 103mm spacing.
Warranty	15 year product warranty

Sustainability



Finish



Installation

dECO Blades is installed on the Verto™ system that can be direct fixed, suspended from soffit or ceiling grid. For more details, refer to Accessories on page 47.

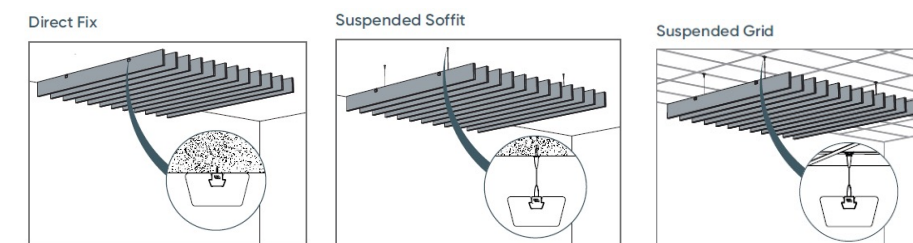



Features dECO Screens Lines in dECO Felt Bumble Bee



martini dECO SCREEN

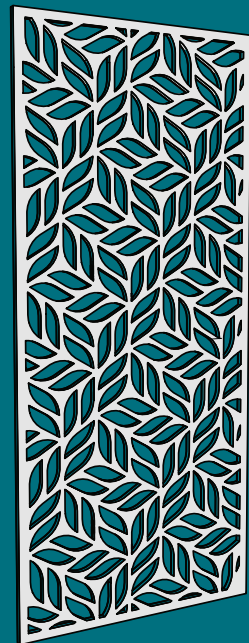

Leaf

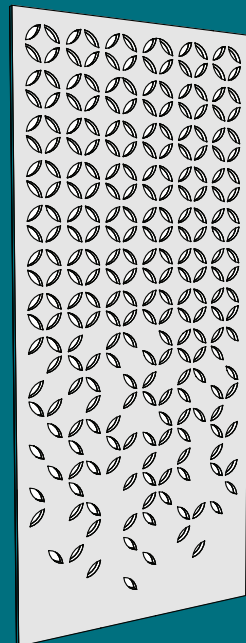

Breeze

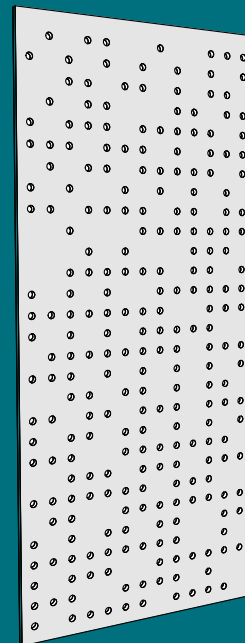

Dots

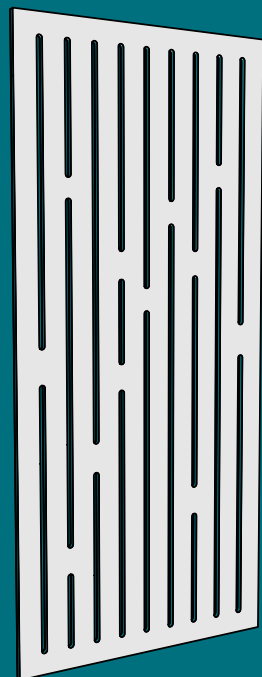

Lines

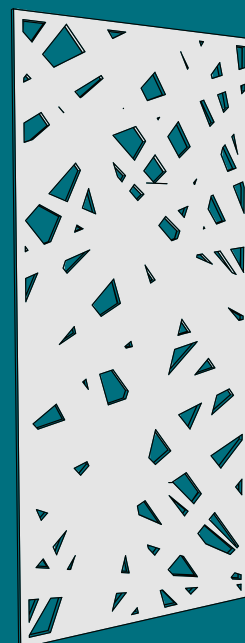

Fracture

Interior Decorative Acoustic Screen

Applications	Vertical hanging decorative acoustic room divider or wall features
Designs	dECO Screens Leaf, dECO Screens Lines, dECO Screens Dots, dECO Screens Breeze, dECO Screens Fracture.
Thickness	27mm Tolerance: +/- 2mm
Height	Available in 2400mm or 2700mm
Fire resistance	Complies with AS 5637.1 and is tested to AS/ ISO 9705 and achieves Group 1-S SMOGRA less than 100 m ² /s ² x 1000
Acoustic performance	Tested to AS/ISO 354 and dECO Screens substrate achieves NRC 0.65 direct fix
Warranty	15 year product warranty

Sustainability



Finish



As shown on page 8

Installation

dECO Screens are installed on the Verto™ system that can be direct fixed, suspended from soffit or ceiling grid, free hanging or under tension. For more details, refer to dECO Screens datasheet and Installation Guide.

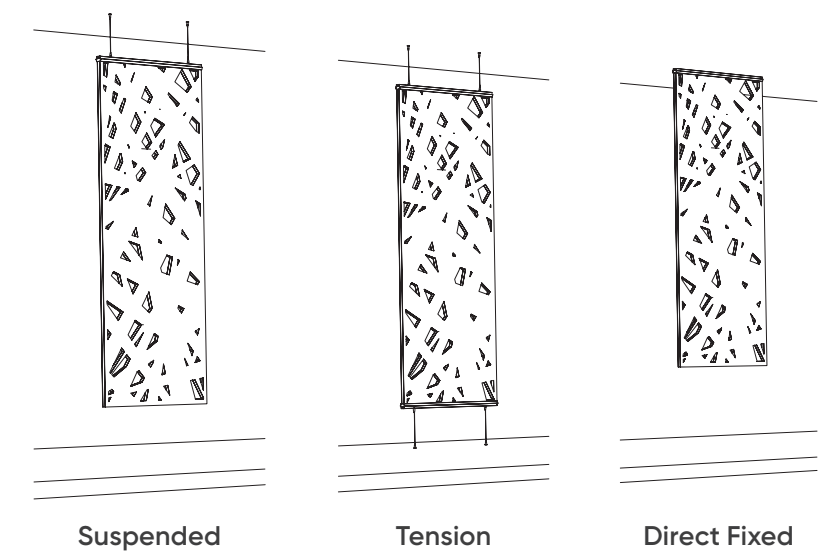

Decorative Suspended Acoustic Clouds

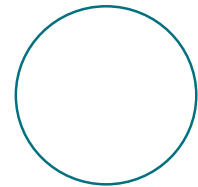

Circle

1200mm, 800mm,
600mm diameter



Rectangle

2400 x 1200 x 25mm

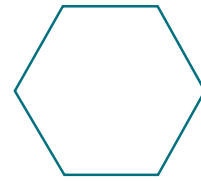

Hexagon

1200 x 1200 x 25mm



Square

1200 x 1200 x 25mm

Application

For interior ceiling applications

Design

dECO Clouds Circle 1200mm, dECO Clouds Circle 800mm, dECO Clouds Circle 600mm, dECO Clouds Rectangle, dECO Clouds Square, dECO Clouds Hexagon

Thickness

25 mm
Tolerance: +/- 2mm

Fire resistance

Complies with AS 5637.1 and is tested to AS/ ISO 9705 and achieves Group 1-S SMOGRA less than 100 m²/s² x 1000

Acoustic performance

Tested to AS/ISO 354 and achieves NRC 0.90 direct fix. Refer to dECO Tiles datasheet for Effective Absorptive Area (metric Sabine) results

Warranty

15 year product warranty

Finish



As shown on page 8

Installation

dECO Screens can be suspended from soffit or ceiling grid using dECO Clouds Suspension Kit. Refer to dECO Screens datasheet for number of required suspension kits per design



Soffit features dECO Deluxe 24mm in black with dECO Clouds Circle in dECO Felt Sapphire, Summit and Granite suspended below.



martini dECO CEILING TILES

Decorative Acoustic Drop-In Ceiling Tiles For Grids

Application Decorative acoustic interior drop-in ceiling tiles for standard exposed 24mm ceiling grid systems

Size 1195mm x 595mm x 25mm

Piece /box 4 tiles

Edge type

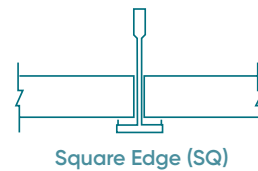

Light reflectance Snow achieves 91 as tested to ASTM E1477-98a

Fire resistance Complies with AS 5637.1 and is tested to AS/ ISO 9705 and achieves Group 1-S SMOGRA less than 100 m²/s² x 1000

Acoustic performance Tested to AS/ISO 354 and achieves NRC 0.65 direct fix. Refer to dECO Clouds datasheet for Effective Absorptive Area (metric Sabine) results

Warranty 15 year product warranty

Finish



As shown on page 8



Features dECO Ceiling Tiles 25mm in dECO Felt Summit and OWA Sinfonia Balance Mineral Fibre Tiles.



CAFE

Features dECO 3D Tiles Geo and Incline in dECO Felt Citrus, Granite, Platinum and Ash. Martini Absorb is featured behind timber panelling.

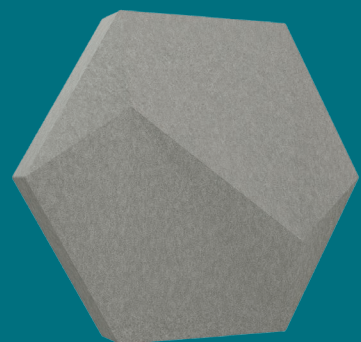

Abstract

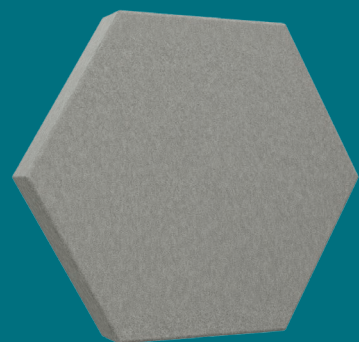

Geo

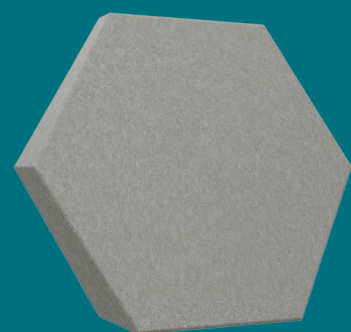

Incline

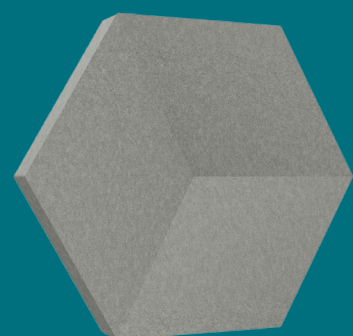

Rubix

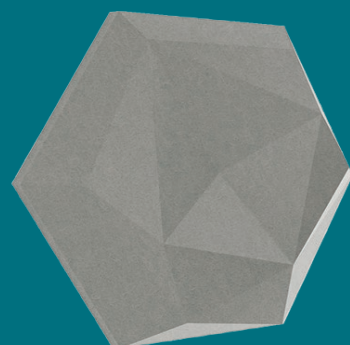

Shatter

3D Decorative Acoustic Wall Tiles

Application	Decorative acoustic three-dimensional wall feature tiles suitable for flat and even surfaces such as Gyprock®
Size	dECO 3D Tiles Abstract and Incline 300mm x 346mm x 70mm dECO 3D Tiles Geo, Rubix and Shatter 300mm x 346 x 40mm
Tiles /box	8 tiles with acoustic infills. MOQ 3 boxes
Fire resistance	Complies with AS 5637.1 and is tested to AS/ ISO 9705 and achieves Group 1-S SMOGRA less than 100 m ² /s ² x 1000
Acoustic performance	Tested to AS/ISO 354 with acoustic infill and achieves Abstract: NRC 0.95 Geo: NRC 0.95 Incline: NRC 0.95 Rubix: NRC 0.75 Shatter: NRC 1.00
Warranty	15 year product warranty
Installation	dECO 3D Tiles are friction-fit mounted on acoustic infill which is attached to the wall with pressure-sensitive adhesive backing. Spacing jig included in tile pack

Sustainability



Finish



As shown on page 8



Wall features dECO Stick It Chevron Sapphire, Granite and Cherry.
Ceiling features OWA Sinfonia Balance Mineral Fibre Tiles.



martini dECO STICK IT

Versatile, Self-Adhesive Acoustic Wall Tiles

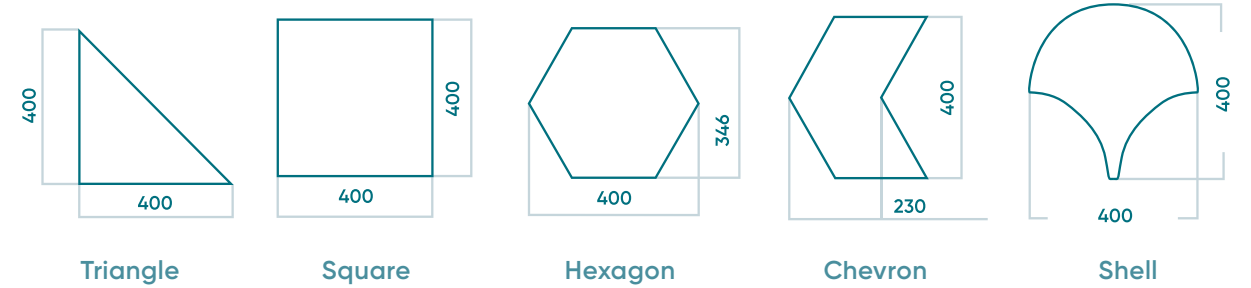

Application	Interior use only, adhered to a flat surfaces such as Gyprock®
Thickness	13.5mm Tolerance: +/- 2mm
Fire resistance	Tested to AS/NZS 1530.3 and achieves Ignitability Index 8 Spread of Flame Index 0 Heat Evolved Index 3 Smoke Developed Index 7
Acoustic performance	Tested to AS/ISO 354 and achieves NRC 0.50 direct fix
Warranty	15 year product warranty
Installation	With self-adhesive backing, dECO Stick It are easy to install onto a wall

Sustainability







Finish  As shown on page 8





Why performance matters?

In some applications, acoustic performance governs over aesthetics. CSR Martini has a range of speciality high performance acoustic boards to meet these demanding acoustical challenges.

dECO Deluxe and dECO Quiet Board are acoustic boards that can be used in exposed and semi-exposed applications where a decorative finish isn't required.



High Density and Durable Acoustic Board

Application	Interior wall or ceiling finish and substrate for fabric wrapping
Thickness	24 mm Tolerance: +/- 2mm
Panel size	2420mm x 1210mm Tolerance: length +/- 10mm width +/- 5mm
Fire resistance	Complies with AS 5637.1 and is tested to AS/ ISO 9705 and achieves Group 1-S SMOGRA less than 100 m ² /s ² x 1000
Acoustic performance	Tested to AS/ISO 354 and achieves NRC 0.65 direct fix
Warranty	15 year product warranty
Colours	Black and White



High Performance and Durable Acoustic board

Application	Acoustic cover-grade substrate for interior walls and ceilings
Thickness	7 mm, 12mm, 25mm, 50mm Tolerance: +/- 2mm
Panel size	2420mm x 1210mm 2720mm x 1210mm Tolerance: length +/- 10mm width +/- 5mm
Fire resistance	Complies with AS 5637.1 and is tested to AS/ ISO 9705 and achieves Group 1-S SMOGRA less than 100 m ² /s ² x 1000
Acoustic performance	Tested to AS/ISO 354 and achieves: 8mm NRC 0.30 direct fix 15mm NRC 0.50 direct fix 25mm NRC 0.85 direct fix 50mm NRC 1.00 direct fix
Warranty	15 year product warranty
Colours	Black and White

Board surface variations may be present. If decorative finish is required, please use dECO Quiet Panel. Refer to page 16.



Make it yours

At CSR Martini we believe science, performance and design are equal, we like to redefine environments and challenge the status quo.

Our engineering and design team have the expertise and capacity to customise designs and transform spaces to suit your commercial, school or special project.

If you are interested in customising dECO Blades, dECO Screens or dECO Clouds to enhance your next project contact your CSR Martini representative or visit www.csmartini/contactus

DREAM
BIG
WORK
HARD

imagine,
believe,
achieve



dECO Collection Accessories

dECO Edge

dECO Edge is an aluminium framing system used in conjunction with dECO Quiet Panel a stylish finish for walls and ceilings.

Available in 3 thicknesses and 3 colours, this product is easy to install and provides a modern, stylish edge finish.

Thickness 15mm, 25mm, 50mm

Profile

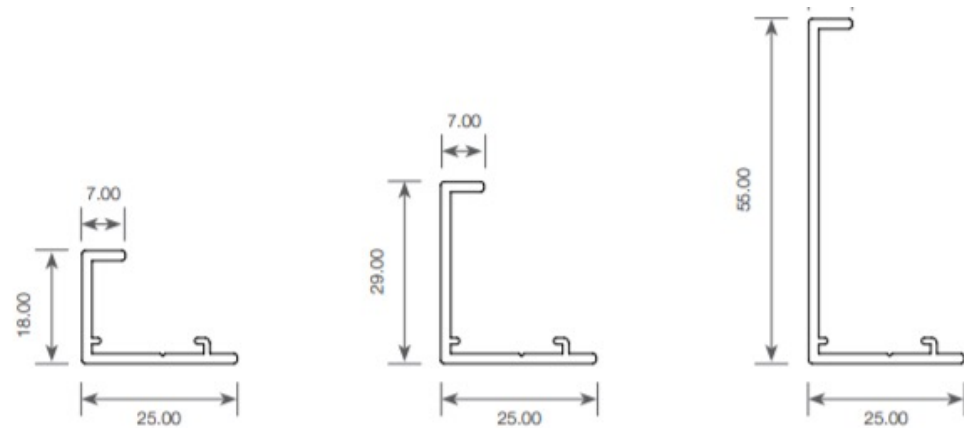

dECO Edge 15mm

Suitable for dECO Quiet Panel 15mm

dECO Edge 25mm

Suitable for dECO Quiet Panel 25mm

dECO Edge 50mm

Suitable for dECO Quiet Panel 50mm

Length 2.8m

Warranty 10 years

Colours

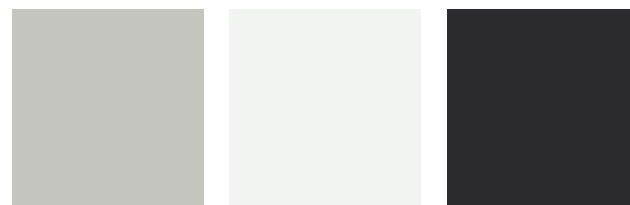

Clear Anodised Silver, Flat White and Matt Black.

Custom RAL colours are also available. Please contact your CSR Martini representative for more details.



Wall Features dECO Quiet Panel 25mm in dECO Velour Apple installed with dECO Edge 25mm Clear Anodised.

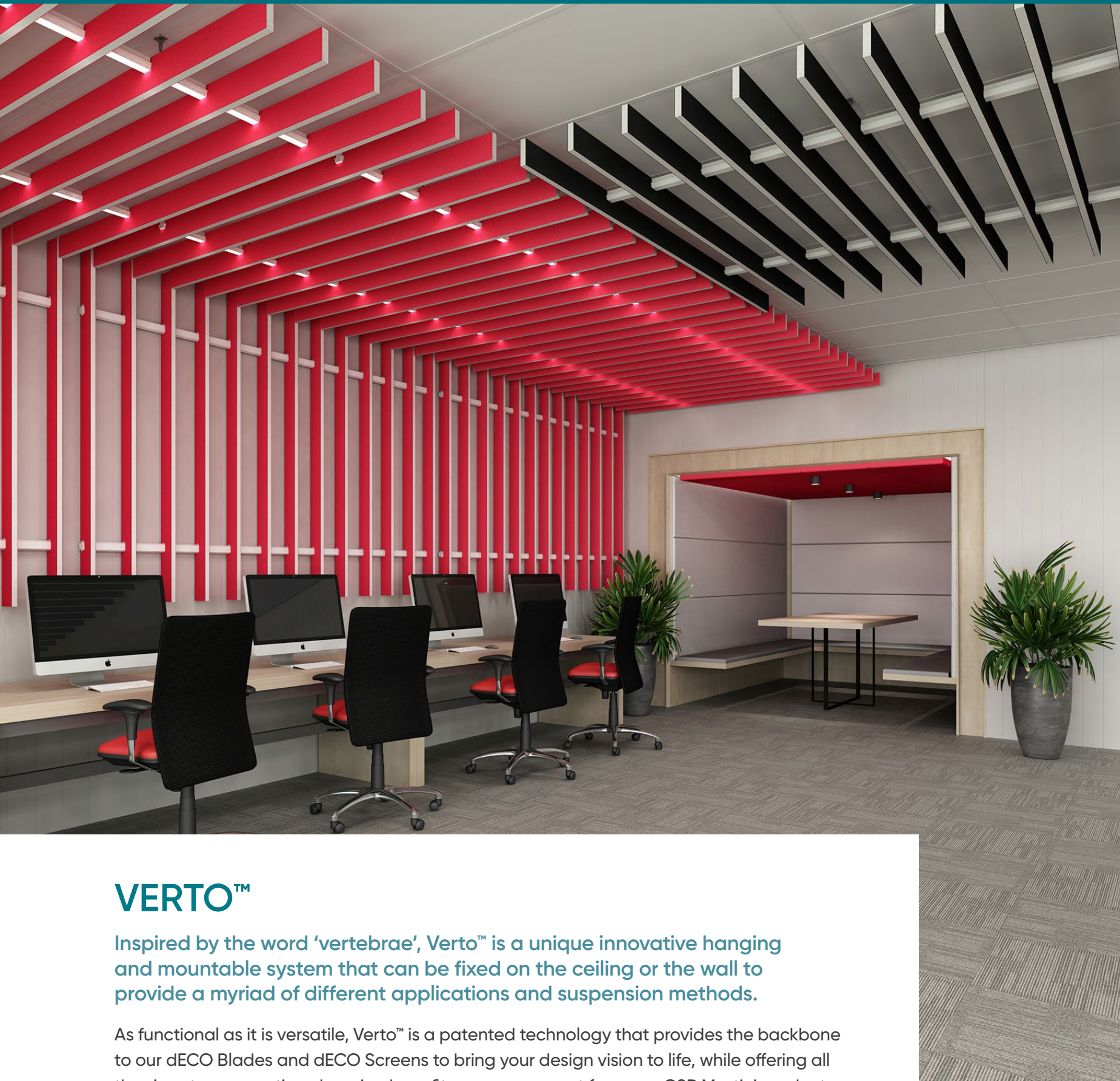

VERTO™

Inspired by the word 'vertebrae', Verto™ is a unique innovative hanging and mountable system that can be fixed on the ceiling or the wall to provide a myriad of different applications and suspension methods.

As functional as it is versatile, Verto™ is a patented technology that provides the backbone to our dECO Blades and dECO Screens to bring your design vision to life, while offering all the signature acoustic enhancing benefits you can expect from any CSR Martini product.

Verto™ System Overview

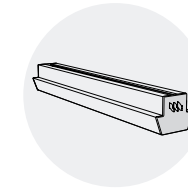

Verto™ Extrusion

Engineered aluminium modular mounting system designed for dECO Blades and dECO Screens.

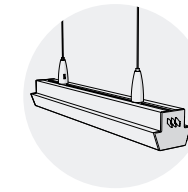

Hardware

The hardware options available give you the flexibility to fix on a ceiling or a wall providing a range of different executions and interior suspension effects.

- Suspended Grid
- Suspended Soffit
- Direct Fix
- Tension (dECO Screens only)

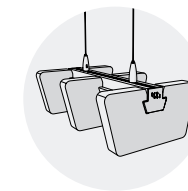

Snap Technology

The exclusive snap blade technology allows for quick and simple installation with the confidence of an instant secure fit.

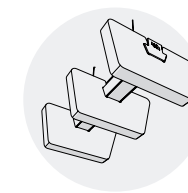

Spacing Versatility

Providing a conceal bespoke finish, the aluminium snap spacer allows for consistent spacing between blades based on your project needs whilst giving you speed for a quick installation.

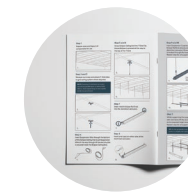

Assembly Support

Detailed illustrations are available in the Installation guide for each unique hardware execution. CSR Martini also offer technical support if required on all projects.



For more details, scan the QR code or visit csmartini.com.au

Proudly distributed by



GORGIAS
GROUP

Contact

Gorgias Group Company Limited
118 Sukhaphiban 5 Soi 5 Yeak 13 Tha
Reang, Bang Khen, Bangkok Thailand
Phone 02-552-6468
Fax 02-552-6469
Info@gorgiasgroup.com